

BUY METAL ROOFING  
**DIRECT**

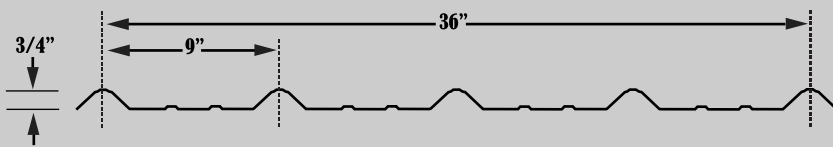

AVAILABLE IN

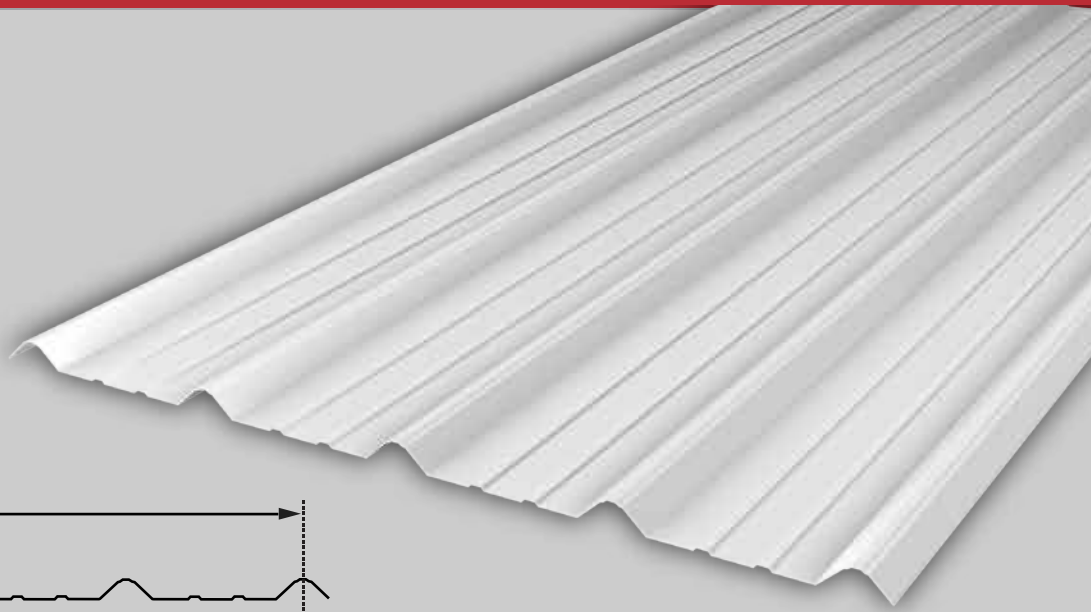

GALVALUME®

# TUFF RIB INSTALLATION MANUAL

# TABLE OF CONTENTS

Important Notice/Safety/Storage/Tools.....	1
Product Information.....	2
Roofing Anatomy/Side Trim .....	3
Measuring Your Roof.....	4
Roofing Installation/Felt/Cutting Panels.....	5
Radiant Barrier.....	6
Purlin Installation .....	7
Drip Edge Installation .....	8
W Valley Installation .....	9
Fastening Schedule/Proper Screw Installation .....	10,11
Pre-drilling Panels/Overlapping Panels.....	12,13
Squaring Panels.....	14
Transition Flashing Installation .....	15
Endwall Installation.....	16
Sidewall Installation.....	17
Gable Trim Installation .....	18
Hip Cap Installation.....	19
Ridge Cap Installation.....	20
Roof Boot Installation.....	21
Special Trim Information.....	22
Care and Maintenance.....	23
Policies.....	24
Order Form .....	25



## IMPORTANT NOTICE

- This manual is to aid the installer with the installation of the Tuff RIB panel. Due to the different complexities of roofs and roofing situations, it is difficult to create a manual that covers every situation that the installer may encounter.
- This manual is to serve as a guideline to properly installing the Tuff RIB panel.
- Check with local building codes prior to installing metal roofing.
- Any questions you may have regarding proper installation of the Tuff RIB panel should be directed to a representative.

## TOOLS RECOMMENDED

Variable Speed Drill or Screw Gun, Snips, Magnetic Bit, Extension Ladder, Turbo Shears (we stock these for purchase), Tape Measure, Hand Bending Tools, Chalk Line, String Line, Drill Bits, Tool Belt, and Utility Knife

## SAFETY

- Failure to observe proper roofing safety can result in serious injury or death. Extreme caution should be used at all times when installing metal roofing. The information in this manual is to show the correct placement of the metal roofing parts. It is the responsibility of the erector to perform the placement of these parts in a safe manner. Refer to OSHA guidelines for applicable safety requirements.
- Never walk on a wet metal roof.
- Never walk on an unfastened roof panel.

## STORAGE/HANDLING

- **Important:** Moisture trapped between stacked sheets may cause water stains or white rust to form under the paint, which can affect the life and service of the metal.
- If metal is not used immediately, store in a well ventilated dry location.
- Any outdoor storage is at the customer's own risk! If outdoor storage cannot be avoided the likelihood of damage may be reduced by protecting the metal using a canvas or waterproof paper.
- Fan sheets lightly at the bottom to allow for air circulation.
- **Keep the sheets off the ground** by using an insulator such as wood.
- **Never cover the metal with plastic** as this will cause condensation to form.



# TUFF RIB PRODUCT INFORMATION

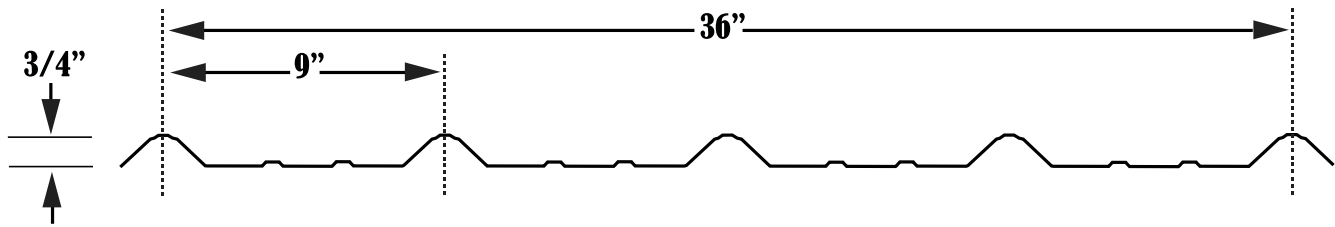

**Applications:** Residential, Light Commercial, Industrial, Agricultural  
**Gauge:** 26 gauge and 29 gauge - exceeds FL Bldg Codes specifications

**Minimum Slope:** 2 / 12

**Panel Profile:** 36" net coverage, 5 ribs 9" on-center, 3/4" high rib

**Substrate:** Galvalume® steel sheet, conforming to ASTM A792

**Finish:** Mill Finish AZ55 Acrylic Coated Galvalume®; 25 year limited warranty

**TCM exclusive paint systems:**

Core Defender Paint System® 40 / 30 year limited warranty.

Max Defender Paint System® 35 / 30 year limited warranty.

**PLEASE NOTE:** For other installation configurations, please inquire with your salesperson for site-specific accommodations.

## FLORIDA PRODUCT APPROVALS

A current list Florida Product Approvals available on our website.

For the most up-to-date Florida Product Approvals, please visit our website:

[TriCountyMetals.com/florida-product-approvals/](http://TriCountyMetals.com/florida-product-approvals/)

## RECOMMENDED ACCESSORIES:

Lifetime WoodZac fasteners  
(250 screws / bag)



# ROOFING ANATOMY



# SIDING TRIM

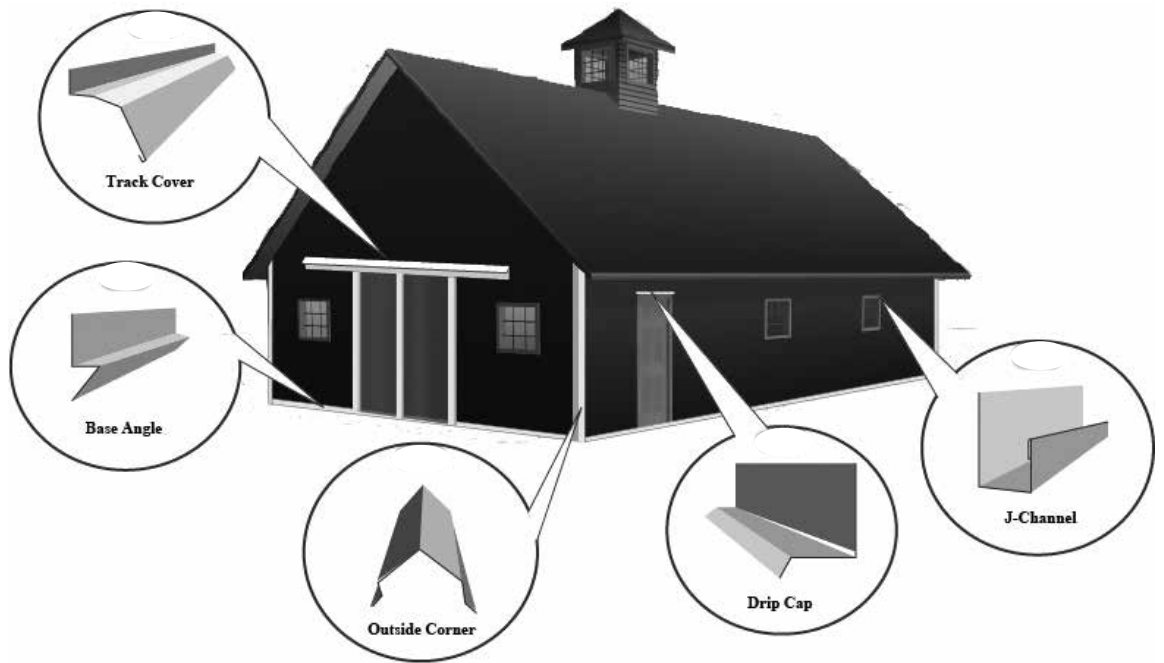

Please refer to the drawing above when ordering siding

# MEASURING YOUR ROOF FOR AN ESTIMATE

- > Start by sketching a birds eye view of your roof. This can be aided by using Google Earth or similar online programs.
- > Identify each part of your roof similar to the drawing below.
- > Once you have drawn your roof and identified each part, measure each line and include it on the drawing.
- > Include on the drawing the location of plumbing stacks (if any) and the diameter of the pipe.

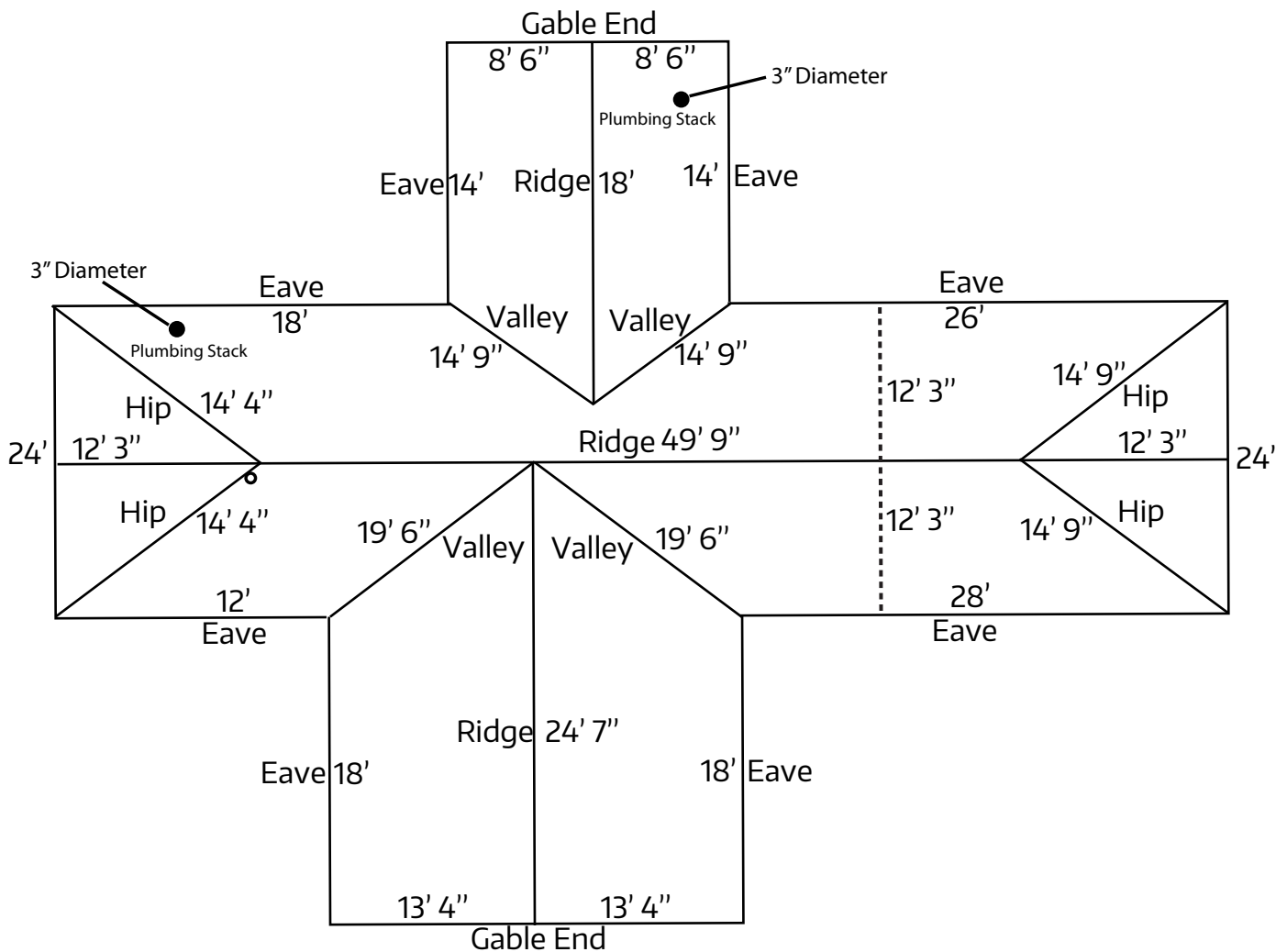

# ROOFING INSTALLATION

The order that items appear in this manual corresponds to the order that they should be installed. Please read carefully and if you have any questions regarding what you read in this manual, please feel free to call us.

**Important:** This manual should only serve as a guide to how the metal roofing should be installed. The installer must check with local building codes before any installation of the roof begins.

## UNDERLAYMENT INSTALLATION

- > Starting at the eave, run the underlayment horizontally at the eave. Fasten underlayment every 6" at the edges and stagger one row of fasteners every 12" through the middle of the underlayment.
- > Endlaps should be staggered every 6'
- > Overlap each row of underlayment 4"
- > See Florida building codes for specific installation.

### WE RECOMMEND AND STOCK THESE UNDERLAYMENTS:

Ultra HT - High Temperature Underlayment and Synthetic Roof Underlayment

## FIELD CUTTING PANELS AND TRIM

- > Trim pieces can be cut with a quality pair of snips.
- > Metal panels can be cut using tin snips, Turbo shears, or scoring the panel with a utility knife. The use of a metal cutting blade can be used but the panel must be cut facing down to avoid hot particles from the Skill saw shavings landing on the panel and damaging the finish. Always remove the shavings off the roof, as they will rust.

### WE RECOMMEND AND STOCK THESE TOOLS:

Midwest Cutting Snips  
Turbo Shears  
Turbo Shears HD  
6" Hand Seamer  
3" Hand Seamer  
Standing Seam Folding Tool



# RADIANT BARRIER INSTALLATION

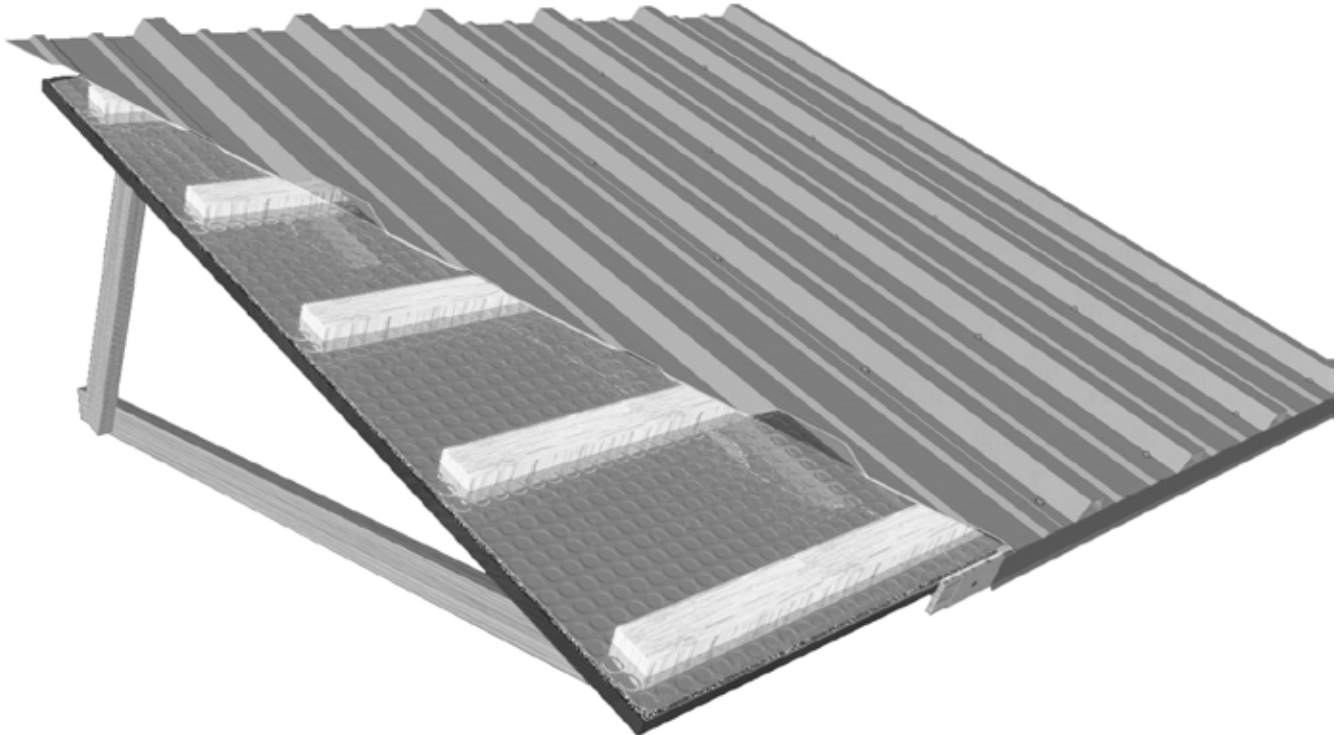

## **Note : SILVER SIDE UP**

1. Fasten Radiant Barrier to roof using plastic caps every 12" on center on the edges and one row through the center every 12" on center ( the purpose of fastening the Radiant Barrier is to hold the Radiant Barrier in place prior to installing purlins.
2. Starting at the eave, run the Radiant Barrier up and over the ridge to the other side. If you are venting the ridge it is easier to cut the Radiant Barrier back along the entire ridge after you have installed the entire roof and 1 x 4's (if applicable).
3. Tape all seem edges with Radiant Barrier tape. **(Optional)**
4. Once Radiant Barrier has been installed over the entire roof, then you are ready for purlins.
5. A 3/4" air space is required with the use of Radiant Barrier for it to work effectively.

**One roll of double bubble = 500 sq. ft. (4' wide x 125' long)**

## **RECOMMENDED ACCESSORIES:**

TCM Radiant Barrier Foil Tape (2" x 150' roll)





# PURLIN SPACING

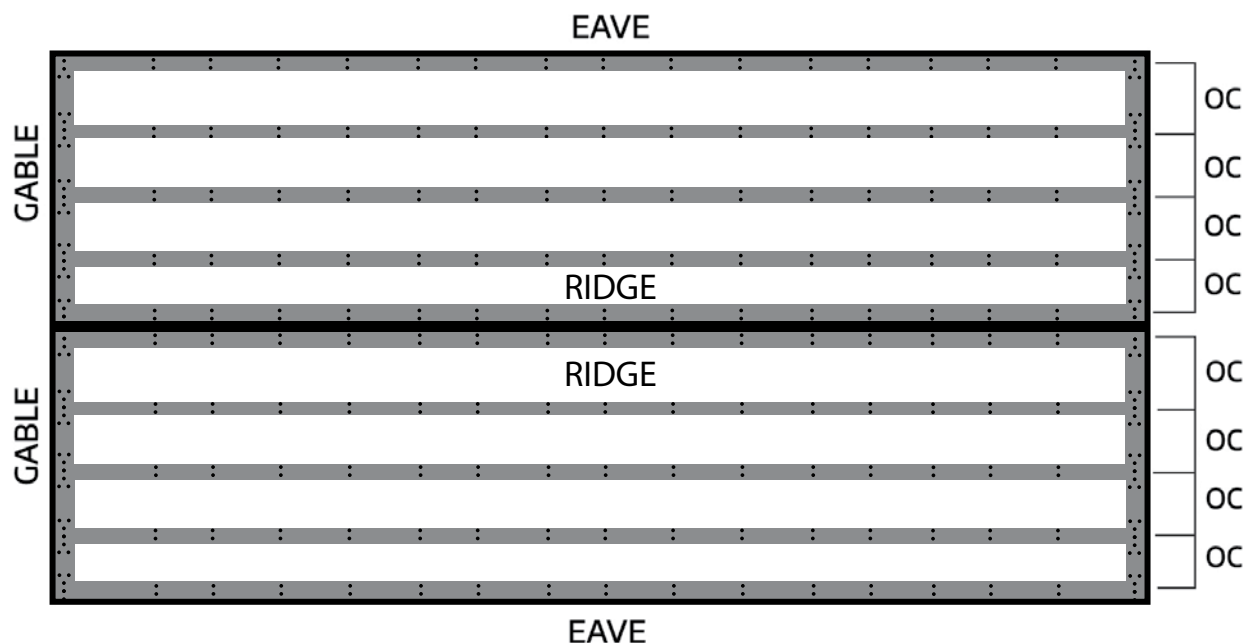

See most up-to-date Florida Product Approvals for purlin spacing, please visit our website:  
[TriCountyMetals.com/florida-product-approvals/](http://TriCountyMetals.com/florida-product-approvals/)

## DO NOT USE PRESSURE TREATED PURLINS. PRESSURE TREATED PURLINS ARE CORROSIVE TO METAL ROOFING

- > The purpose of the purlins is to provide a solid foundation for the metal roofing panels and trim to be screwed to.  
 Therefore, good judgment should be used in order for there to be a solid surface that can be screwed to.
  - > Purlins must be attached to the truss using either 2 #9 x 3" deck screws spaced every 2 feet into roofs trusses or 1 8d x 2 3/8" ring shank nail staggered every 4" on center.
  - > Purlin spacing is according to most up-to-date FPA. See online at [TriCountyMetals.com/florida-product-approvals/](http://TriCountyMetals.com/florida-product-approvals/).
  - > Purlins must be installed to support the entire width and length of the ridge, eave, hip, valley, transition, sidewall, endwall and gable ends.
  - > You will also need to install purlins around penetrations such as plumbing pipes, electrical pipes and skylights to fasten roof boots. (see page 21 for roof boot installation)
- \* Please read ahead in this book for purlin placement on trim detail pages.

One purlin = 1" x 4" x 12' #2 Yellow Pine



# DRIP EDGE

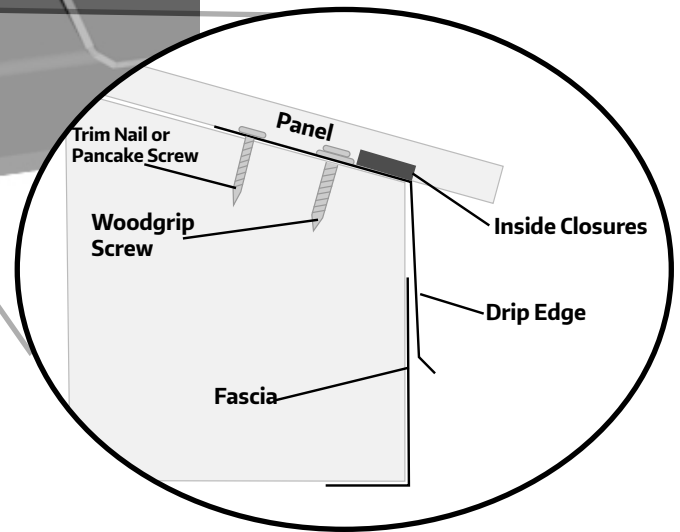
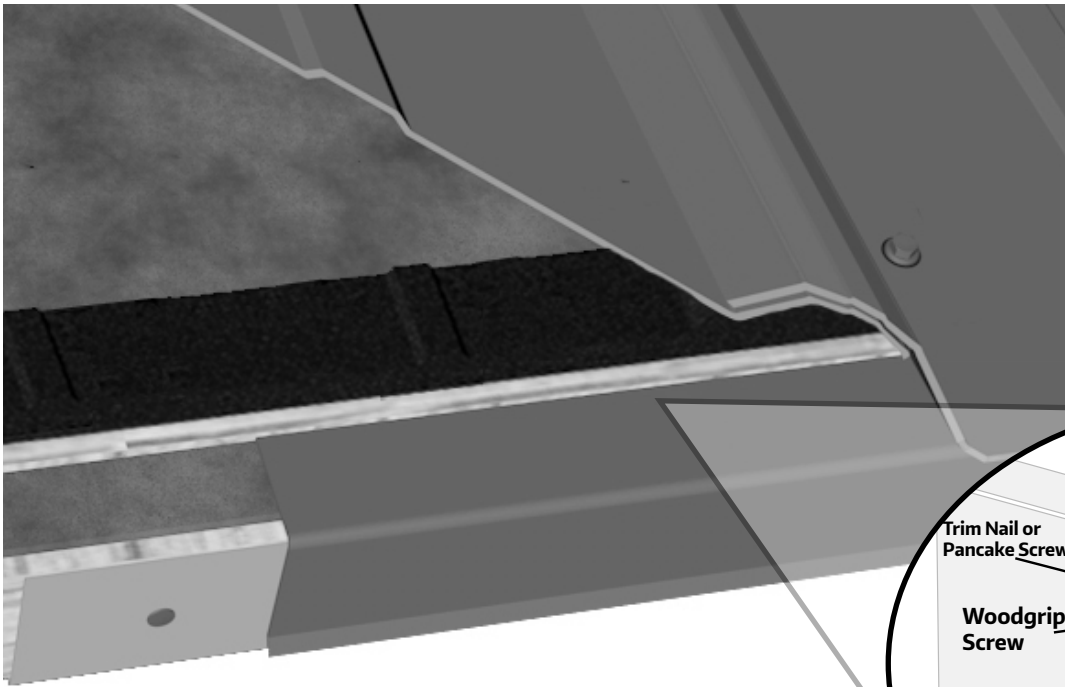

## Notes:

1. Attach Drip Edge flashing to roof deck or purlins with 1 1/4" galvanized roofing nail 4" on center.
2. Install optional inside closures on the top edge of the drip edge flashing.
3. Overlap drip edge flashing a minimum of 3"
4. Allow drip edge to run past corner of roof 3" so it can be folded to ensure maximum weather tightness.
5. Attach roofing panel at eave according to most up-to-date FPA. See online at [TriCountyMetals.com/florida-product-approvals/](http://TriCountyMetals.com/florida-product-approvals/).
6. Panel ends should hang past the eave 2"-3" or 1" for gutters.

\* Purlin placement should be directly above fascia board along the eave line.

## RECOMMENDED ACCESSORIES:

Inside Closures (1 closure = 3' of coverage)

Trim Nails (1 box = 1lb)



# W-VALLEY

Pg.9

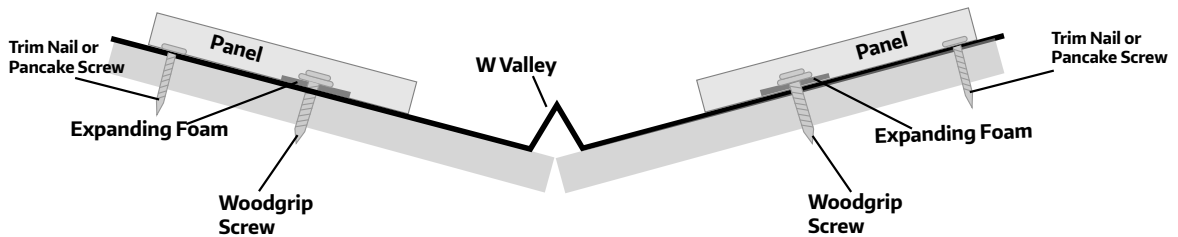
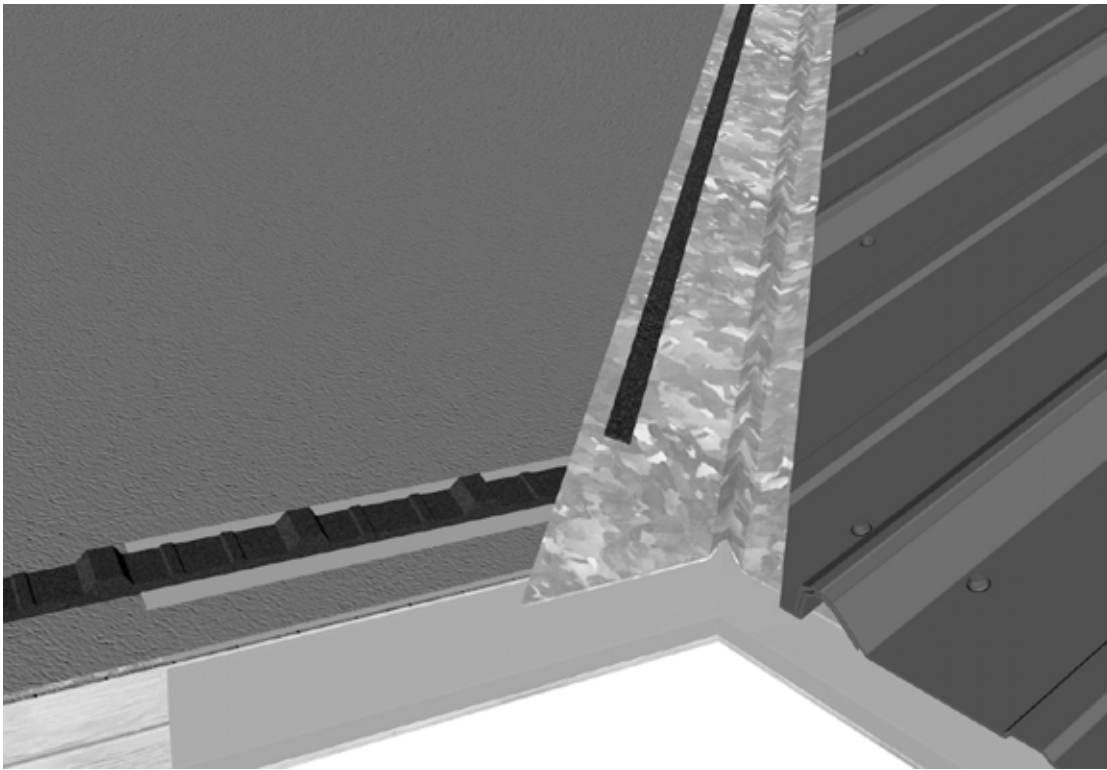

1. Starting at the bottom, fasten W-Valley trim flashing to purlins or substrate using 1 1/4" trim nails 1" from trim edge every 4" on center.
2. The valley trim needs to run past the installed drip edge, or cut flush with drip edge.
3. End lap w-valley flashing a minim of 6 inches, and install 2" of butyl minimum.
4. Apply expanding foam tape to the top of the W-Valley Flashing 1" from the bottom edge of the roofing panel.
5. Fasten roofing panel ends according to most up-to-date FPA. See online at [TriCountyMetals.com/florida-product-approvals/](http://TriCountyMetals.com/florida-product-approvals/).
6. Screws should be installed according to most up-to-date FPA. See online at [TriCountyMetals.com/florida-product-approvals/](http://TriCountyMetals.com/florida-product-approvals/).

\* Purlins should be spaced 1" & 6" from center of valley on both sides.

## RECOMMENDED ACCESSORIES:

Expanding Foam (1 roll = 20' of coverage)



# FASTENING SCHEDULE

**Screw placement both sides of ribs at Eaves, Ridges, Valley Ends, Hip Ends, Transition Ends**

**Purlin bearing rib side intermediate rows, 2 foot on-center**

**Lap screws must be installed as per FL Product Approval chosen for project. Please refer to our website [TriCountyMetals.com/florida-product-approvals/](http://TriCountyMetals.com/florida-product-approvals/)**



**Middle Screw Placement**



**Bottom and Top Edge Screw Placement**



**We recommend use of Lifetime WoodZac fasteners for your metal roofing system.**



# FASTENING SCHEDULE - THRU RIB

For proper screw placement, please refer to the FL Product Approval chosen for you project. See all our FL Product Approvals on our website [TriCountyMetals.com/florida-product-approvals/](http://TriCountyMetals.com/florida-product-approvals/)



## PROPER SCREW INSTALLATION



**Too Tight**

Washer deformed,  
Sealing material  
extrudes beyond  
edge of washer.



**Too Loose**

Sealing material  
isn't visible.  
Not enough  
Compression.



**Correct**

Sealing Material is  
slightly visible at  
edge of washer.  
Assembly is  
weather tight.

**We recommend use of Lifetime WoodZac fasteners  
for your metal roofing system.**



# PREDRILLING PANELS

The placement of screws and ease of installation can be aided by predrilling the roofing panels on the ground using a 3/16" drill bit.

You will also benefit from predrilling the panels on the ground by not having metal filings on the roof or unsightly shavings sticking out from under the screws that will rust.

Predrilling holes for the screws will make the roof look better when viewed from the ground. Although screws can be installed on the roof, the tendency is to have wavy rows of screws.

When predrilling panels, it is recommended to only predrill 10 panels of 29 gauge and 7 panels of 26 gauge.

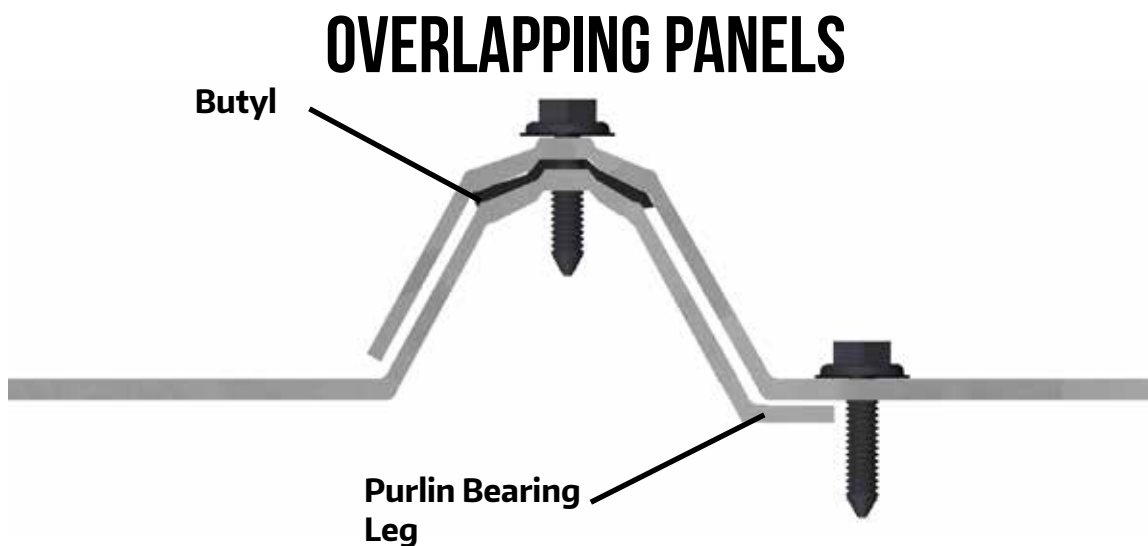

**Notice the purlin bearing leg is installed underneath the overlapping panel.**

### ATTENTION:

**Roofs with less than a 3/12 pitch requires Butyl to be installed the entire length of the panel overlap and the use of lap screws.**

# PREDRILLING PANELS - THUR RIB

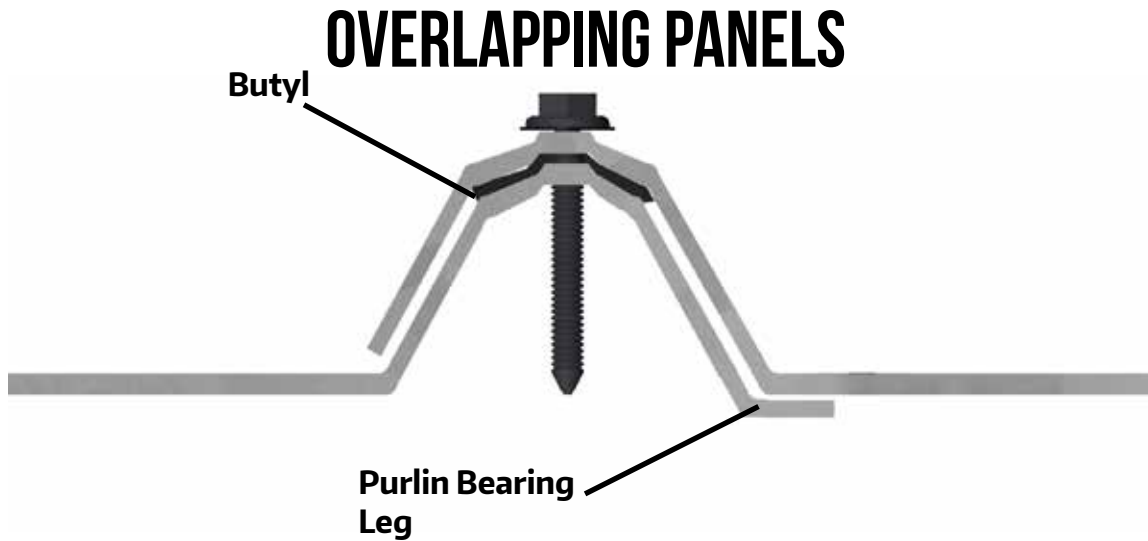

Notice the purlin bearing leg is installed underneath the overlapping panel.

### ATTENTION:

Roofs with less than a 3/12 pitch requires Butyl to be installed the entire length of the panel overlap and the use of lap screws.

# SQUARING PANELS

RIDGE

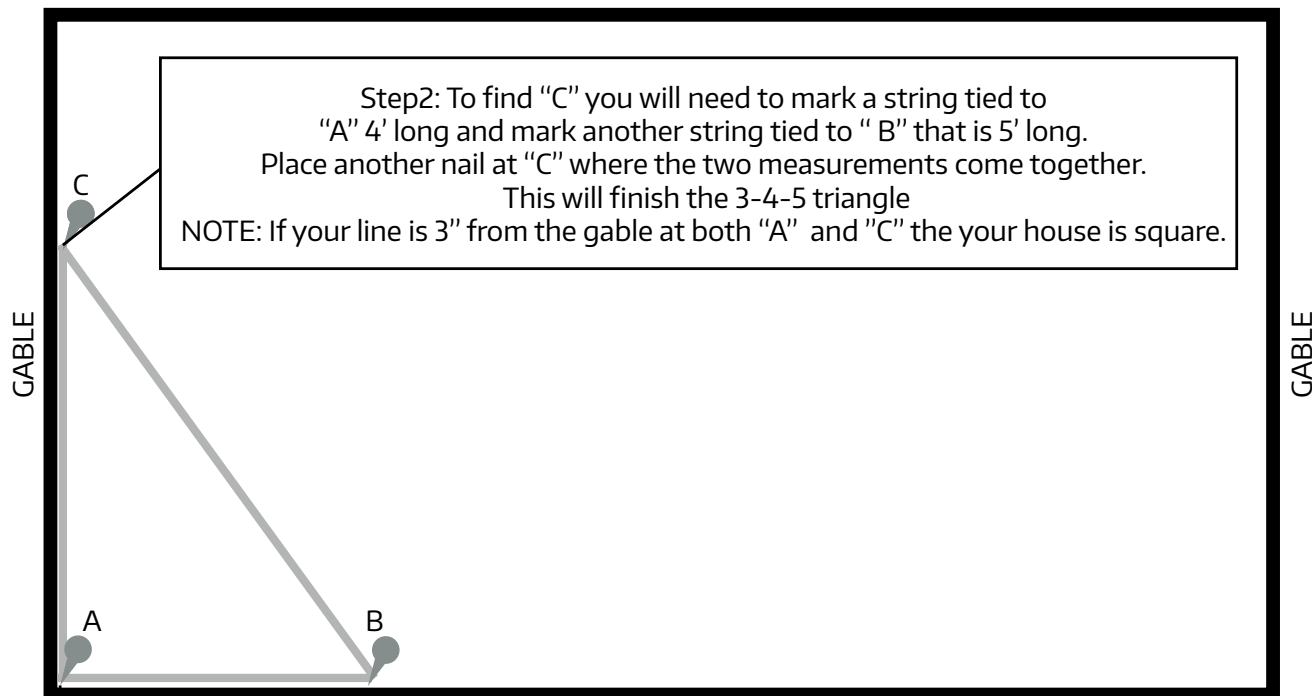

Step 1: Temporarily place a nail 3" from the eave and gable as shown here as "A". Measure 3' parallel on the eave line and place another nail shown here as "B".

The 3-4-5 triangle method will work on a larger scale as well. For example if your roof panels are 16' long then you can multiply the 3-4-5 by 4 so you will be measuring 12-16-20. Just make sure that you multiply all measurements by the same number. The next step will be making a chalk line going from your "point A" to "point C". You will want this line to be as close to the edge of the gable as possible so your first panel will be about an 1/8" from the edge of the roof. You will want to measure 9' 6" from your chalk line at the A and C points and make another chalk line. This will help you as you start installing your panels to make sure they are still square with your eave. It is a good idea to continue this process for the entire project and on both sides of your roof.

Note: If your roof length is a few inches over an even multiple of 3' you will want to take that into consideration when you start installing your panel so that you are not short on the other end of the house. For instance, if your house is 42' 4" wide you can get away with 14 panels. You will just make sure you start your first panel 2" away from the gable end.





# TRANSITION FLASHING

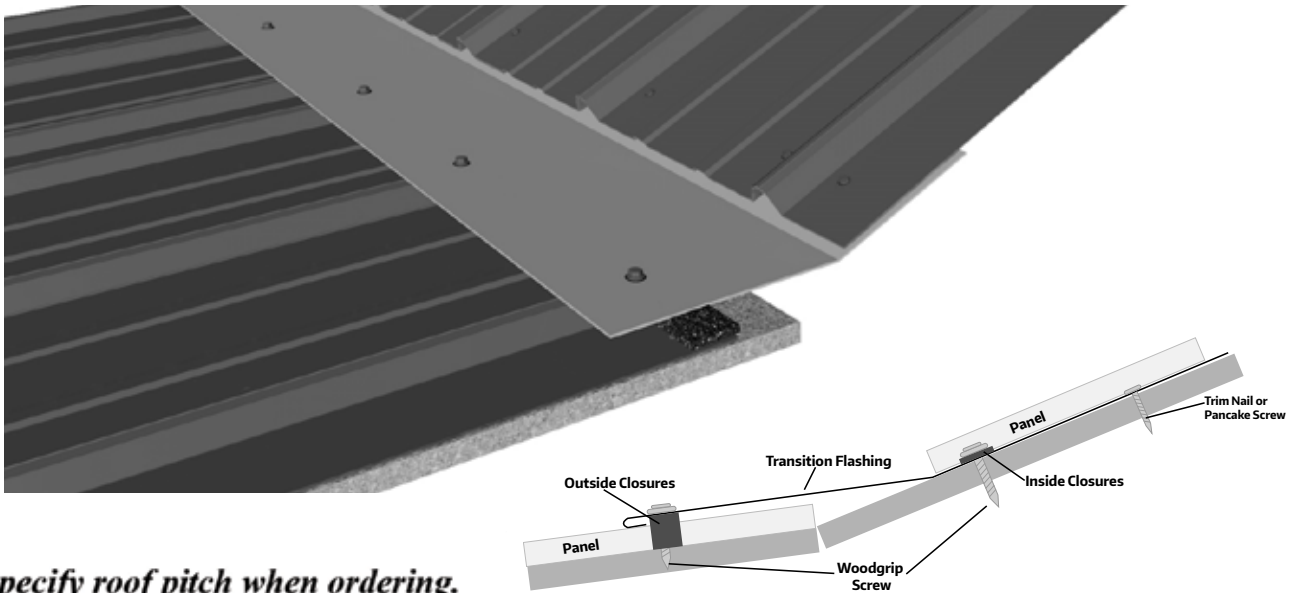

*Please specify roof pitch when ordering.*

## Notes:

1. Install bottom roofing panels first.
2. After bottom roofing panels have been installed, set one piece of transition flashing down where the top portion (non-hemmed) of the transition flashing lies flat on the upper roof.
3. Measure 1 1/2" from bottom edge of transition flashing.
4. Repeat step 3 on the opposite end of the roof transition.
5. Remove transition flashing and pop a chalk line on line previous marked indicating where outside closures are going to be placed.
6. Install outside closures.
7. After outside closures are installed, install the transition flashing over the outside closures.
8. Fasten transition flashing according to most up-to-date FPA. See online at [TriCountyMetals.com/florida-product-approvals/](http://TriCountyMetals.com/florida-product-approvals/).
9. When overlapping transition flashings, flashings should be attached immediately adjacent to a major rib and not in between two major ribs.
10. Once the bottom half of the transition flashing has been installed completely, install the upper roofing panels next overtop the top part of the transition flashing.
11. Hold roofing panels back two inches from the centerline of the transition flashing.
12. Leave bottom row of screws uninstalled so inside closures can be installed later.
13. Once upper roof panels have been installed (except for bottom row of screws), insert inside closures 1" from edge of roofing panel the entire length.
14. Install bottom row of screws into the metal panel catching the inside closures to hold them into place.
15. Bottom row of screws should be placed adjacent to both sides of every major rib.

## RECOMMENDED ACCESSORIES:

Outside Closures, Inside Closures (1 closure = 3' of coverage)



# ENDWALL FLASHING

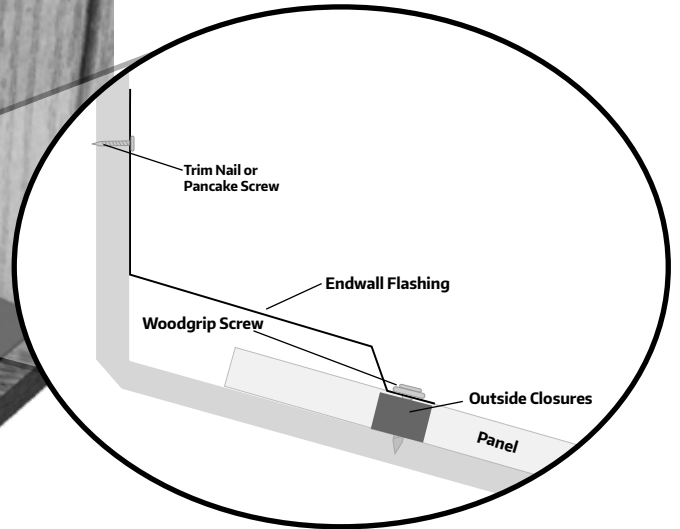
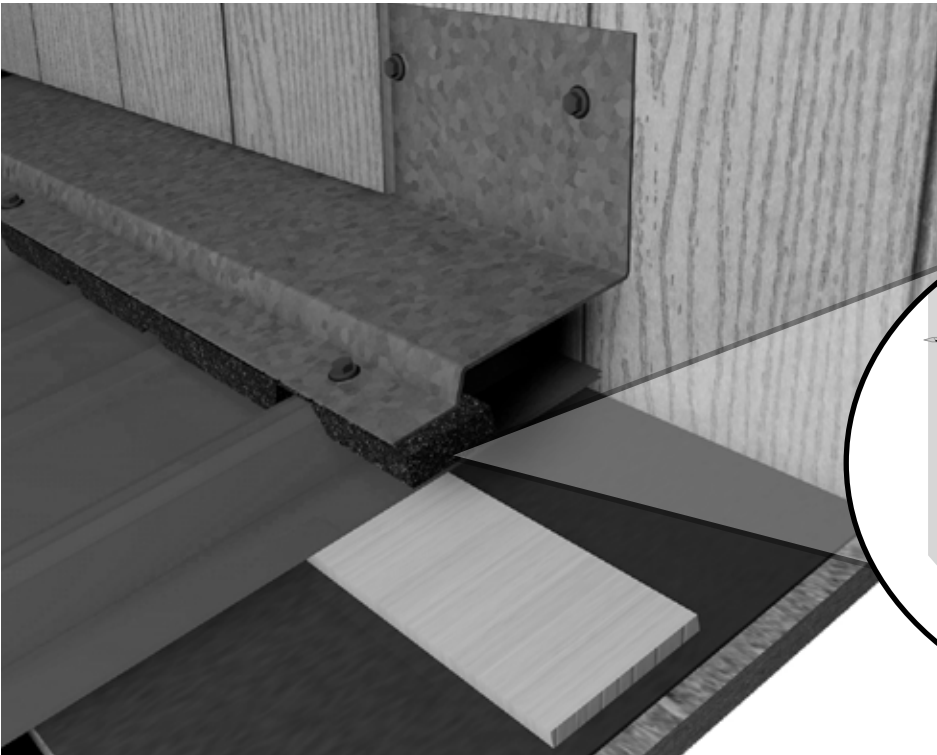

## Notes:

1. Install outside closures where the flat of the endwall flashing will be fastened to the roofing panels.
2. Attach endwall flashing to roofing panels according to most up-to-date FPA. See online at [TriCountyMetals.com/florida-product-approvals/](http://TriCountyMetals.com/florida-product-approvals/).
3. Overlap endwall flashings a minimum of 3" if more than one endwall flashing is required. Two endwall flashing pieces should be attached immediately above a major rib on the roofing panel and not between ribs.
4. It is recommended that the top edge of the endwall flashing be tucked underneath the house siding to provide maximum weather tightness.
5. A counter flashing can be added to the top edge of the endwall flashing to allow the endwall flashing to be inserted into the adjacent wall.
6. As a last resort when the previous two methods can not be performed, a caulk edge can be added to the endwall flashing and then a bead of caulk can be used.

\* Purlin placement should be approximately 1" from the wall.

## RECOMMENDED ACCESSORIES:

Outside Closures (1 closure = 3' of coverage)

Caulking (1 tube = 31 linear feet (1/4" bead)) what this needs



# SIDEWALL FLASHING

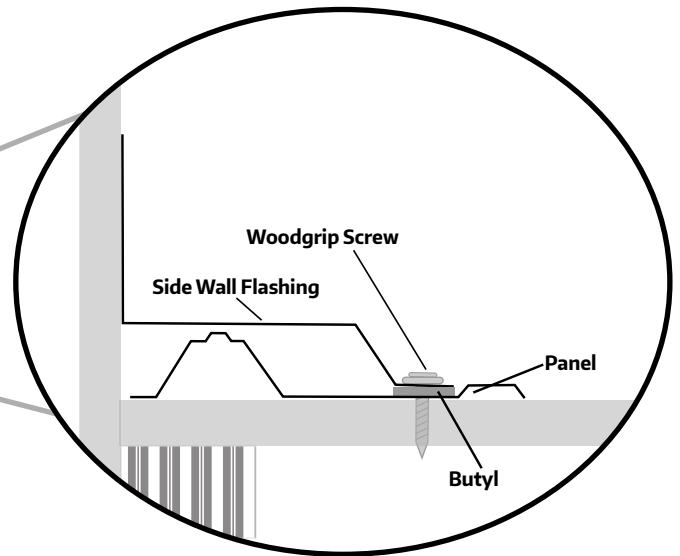
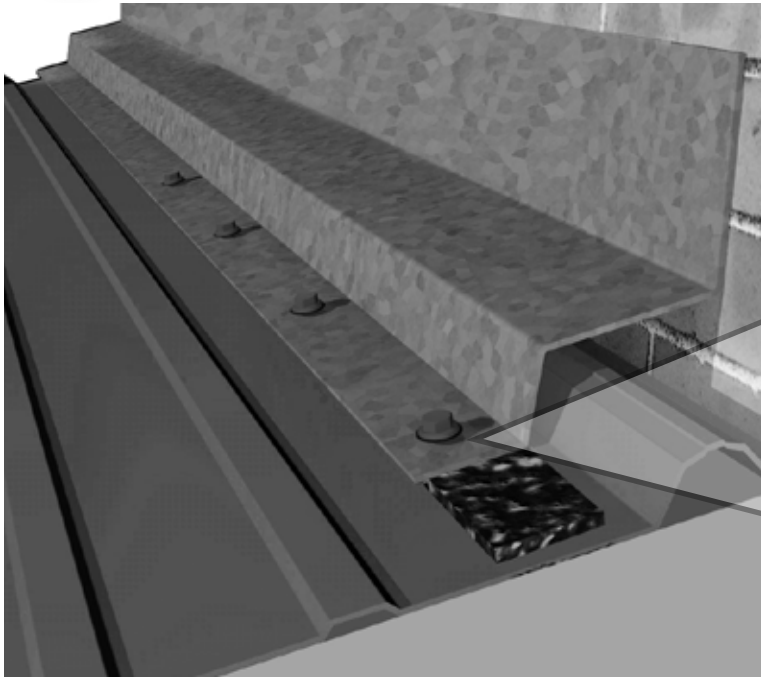

## Notes:

1. Install Butyl the entire length along the bottom edge of the sidewall flashing trim where it is on the roofing panels.
2. Allow 1" at the bottom of the sidewall flashing to be cut and folded in for a finished look.
3. When using sidewall flashing around a dormer, allow 1" at the bottom to be wrapped around the endwall flashing.
4. It is recommended that the top leg of sidewall flashing be installed behind the wall siding. If this cannot be done, then using a countersinking method is preferred.
5. Overlap each piece of sidewall flashing at least 3" or in line with the previous row of roofing panel screws to give it a well finished look.
6. Attach sidewall flashing to roofing panels according to most up-to-date FPA. See online at [TriCountyMetals.com/florida-product-approvals/](http://TriCountyMetals.com/florida-product-approvals/).

\* Purlin placement should be approximately 1" from the wall.

## RECOMMENDED ACCESSORIES:

Butyl (1 roll = 50' of coverage)

# GABLE TRIM

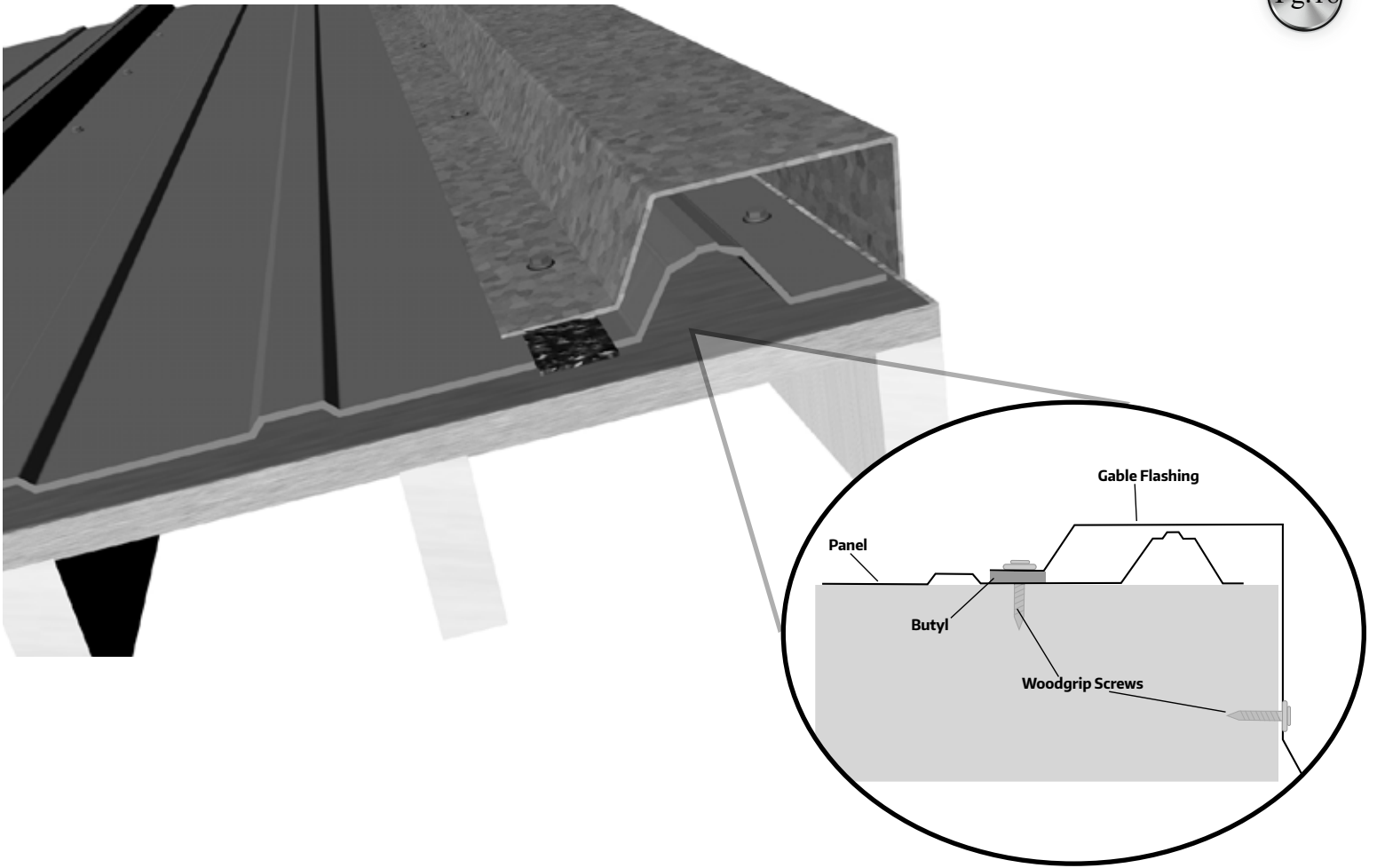

- Notes:**
1. Install Butyl to the bottom of the 1" flat on the gable trim the entire length.
  2. Starting at the eave, attach gable trim flashing to roofing panel according to most up-to-date FPA. See online at [TriCountyMetals.com/florida-product-approvals/](http://TriCountyMetals.com/florida-product-approvals/).
  3. Overlap gable trim flashing a minimum of 3".
  4. Allow gable trim to overhang eave by 1" so gable trim can be folded down to give gable trim a finished look.

\* Purlin placement should be approximately 1" from the gable end running parallel with it.

## RECOMMENDED ACCESSORIES

Butyl (1 roll = 50' of coverage)



# HIP CAP

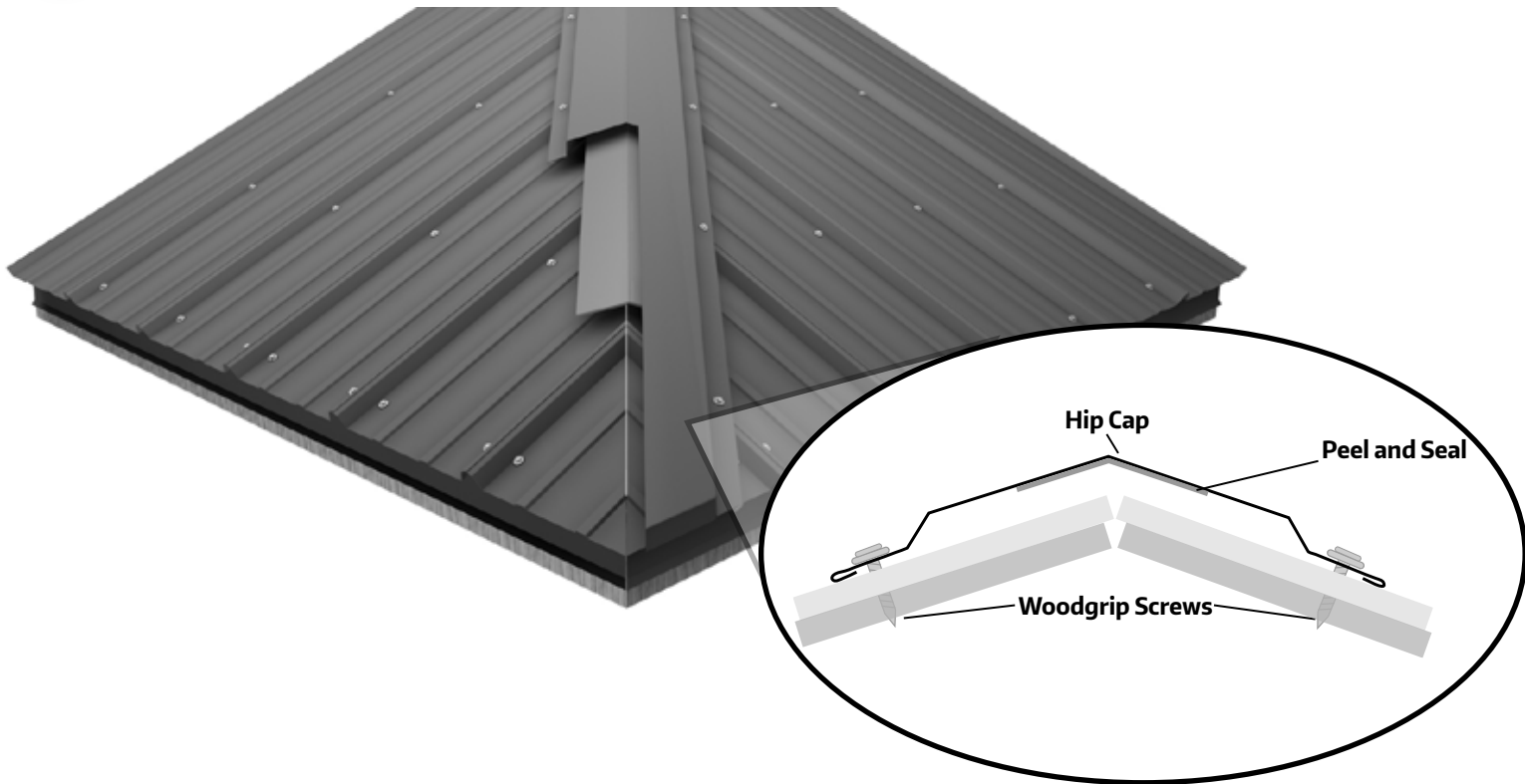

## Notes:

1. Cut the metal roofing panels as close as possible to the hip lines of the roof, but not contacting the opposite side's panels. Allow the metal panels to overhang the desired amount at the bottom of the eaves (1-3" recommended).
2. Apply peel and seal starting at the bottom of the hip. Cut the start of the tape to match the overhang of the metal panels. Overlap peel and seal a minimum of 3". When at the top of the hip overlap the peel and seal to the next side of the hip and/or ridge a minimum of 3".
3. When installing the hip-cap start at the bottom of the hip. Either pre-bend or allow the hip-cap to overhang the metal panels along the eave lines so they may be folded to give a finished look. Overlap the hip-caps a minimum of 3". When at the top of the hip installing the hip-cap, trim cap to match hip and/or ridge lines of the adjacent sides of the roof. Then overlapping the previous piece with the next and trimming to fit and lay flat to give a finished look.
4. Attach hip-cap flashing with minimum # 9 x 2" Woodgrip Screws through each rib on both sides of the hip.

# RIDGE CAP

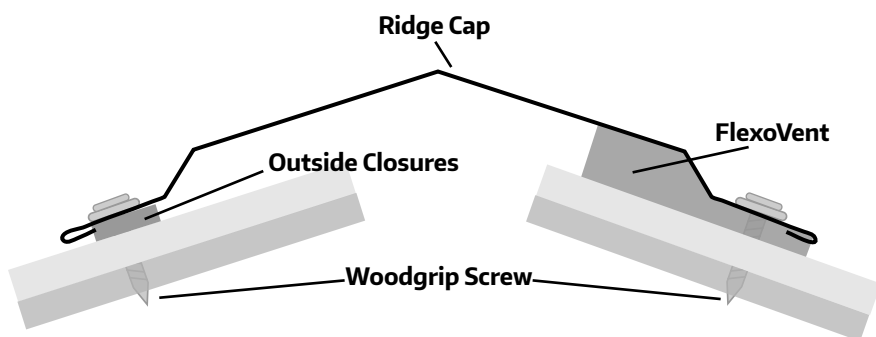
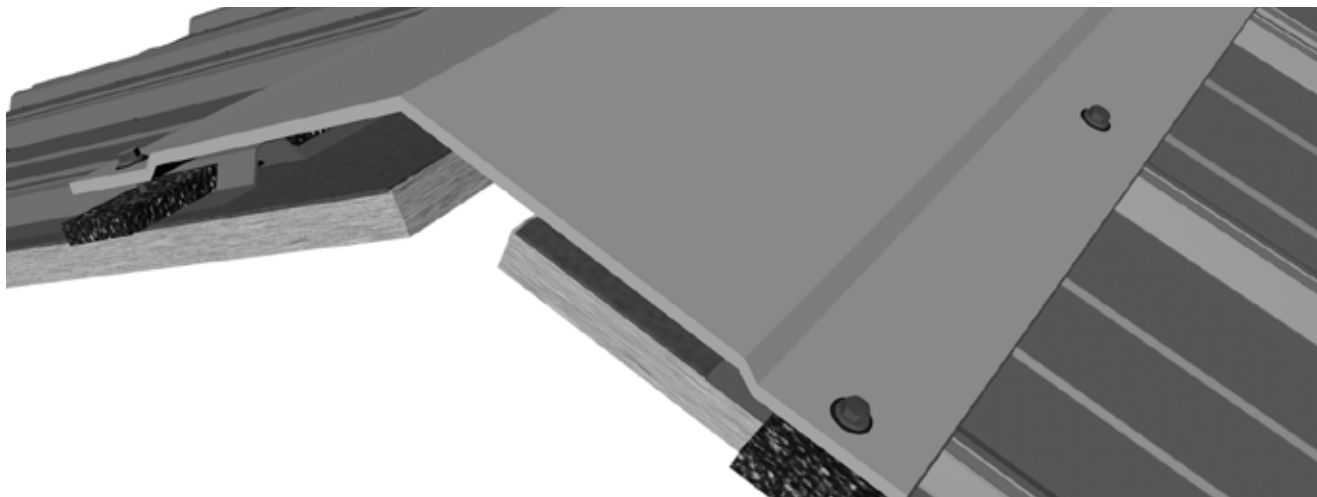

*Please specify roof pitch when ordering.*

## Notes:

1. Stop panels 2" from center line of ridge for vented ridge installation.
2. Install vented, unvented or closures the entire length of the ridge 5" from center line of ridge for a standard ridge cap installation.
3. Attach ridge cap flashing according to most up-to-date FPA.  
See online at [TriCountyMetals.com/florida-product-approvals/](http://TriCountyMetals.com/florida-product-approvals/).
4. Overlap ridge cap pieces a minimum of 3".
5. Allow ridge cap to hang over gable ends approximately 6" so they can be folded down to give ridge a finished look.

\* Purlin placement should be approximately 3" from the center of the ridge line on both sides for the small ridge cap.

## Recommended Accessories:

- Outside Closures (1 closure = 3' of coverage)
- Profile Vent ( sold by the 1' piece)
- Flex-O-Vent(1 box = 20' of coverage)
- FlexPro (1 box = 20' of coverage)



# ROOF BOOT INSTALLATION

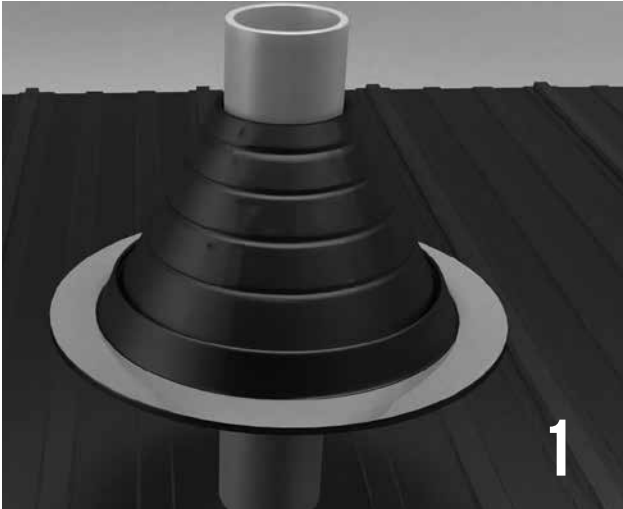

Choose appropriate Master Flash with opening at least 20% smaller than pipe diameter. If necessary trim opening to 20% smaller than pipe diameter.



Slide Master Flash down over pipe. (A nonpetroleum base lubricant will ease installation.)

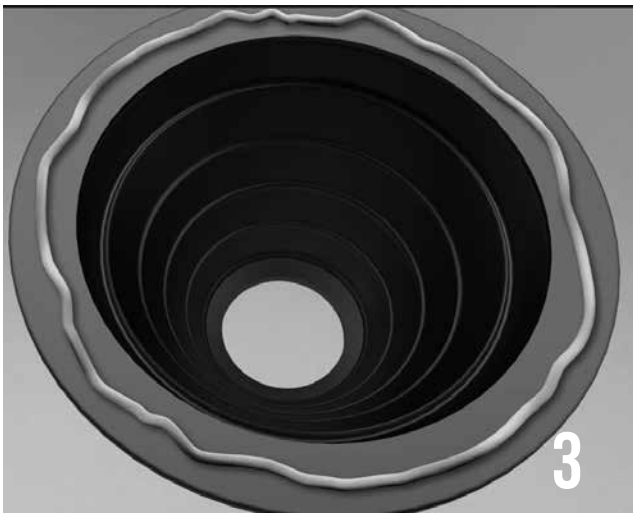

Apply sealant between base and roof.

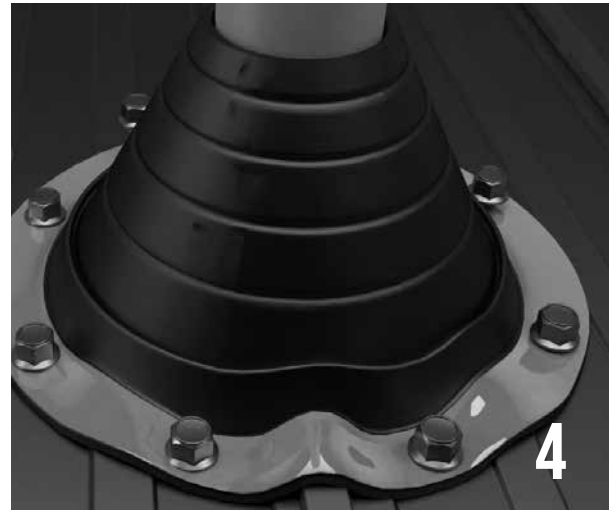

Use fasteners to complete sealing. Space screws no more than 2 1/2" apart around the pipe.

# SPECIAL TRIM INFORMATION

Buy Metal Roofing Direct can manufacture special trim designs separate from those designs included in the manual.

If your project requires special trim, please provide us with the following information:

1. A drawing of the trim design.
2. Clearly marked dimensions of each leg of the drawing.
3. Clearly marked degrees of each angle or roof pitch.
4. Clearly indicate the color side.

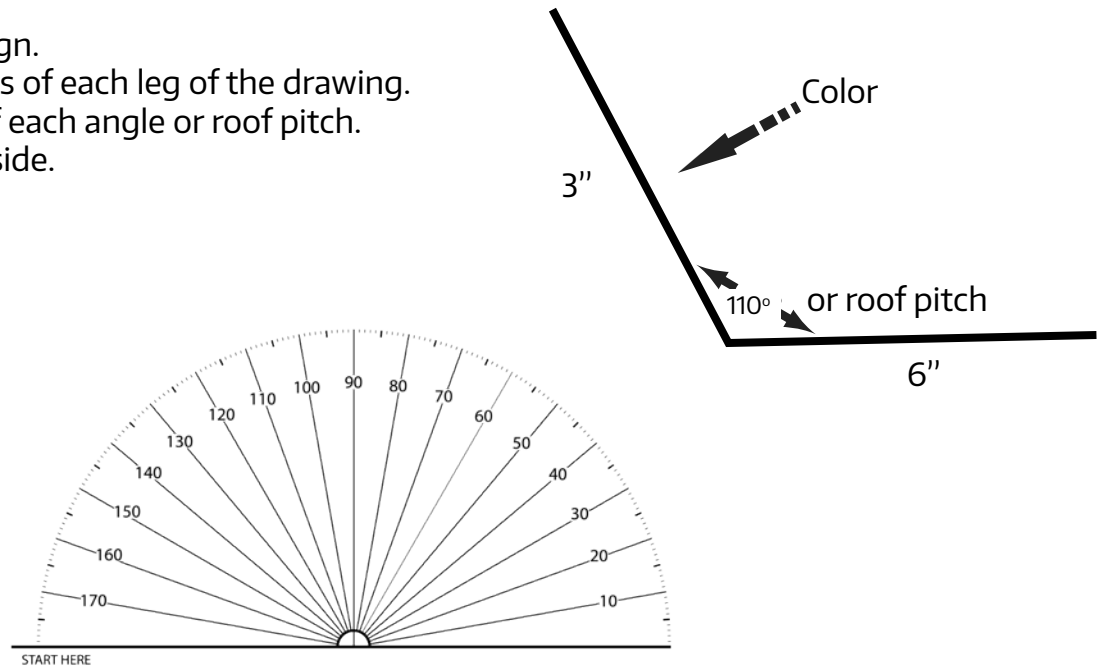

## TRIM MANUFACTURING SPECIFICATIONS

- > Hem size must be 1/2" or larger.
- > Bends on hemmed legs need to be greater than 1/2" or else the hem obstructs the break.
- > Smashed parts need to be at least 1 1/4".
- > Maximum bend break can do is 135 degrees.
- > When bending angles opposite of one another, like that of a Z Flashing, the middle part of the Z must be at least 1/2" or larger.
- > When bending two 90 degree bends on the same side, one leg has to be equal to or less than the length of the material between the two bends.
- > Pieces with more than two bends on the same side are difficult to do unless the bends are large enough. Please talk with a Buy Metal Roofing Direct representative for assistance.
- > For trim pieces that have to slide over another piece where the inside dimensions are critical, please indicate "CRITICAL" measurement.





# CARE AND MAINTENANCE

To maintain the original finish of the metal roofing panels, the only regular maintenance necessary is that of annual washing. Mild solutions of biodegradable cleaner or household ammonia will aid in the removal of most dirt, and the following are recommended levels:

- 1) One cup of Simple Green®, or other non-toxic biodegradable cleaner, which contain less than 0.5% phosphate, dissolved into two gallons of warm water.

NOTE: The use of detergents containing greater than 0.5% phosphate is not recommended for use in general cleaning of building panels. NEVER BLEND CLEANSERS OR DETERGENTS WITH BLEACH.

- 2.) One cup of household ammonia dissolved into five gallons of water (room temperature). Working from the bottom to the top of the metal roofing panels, the panels may be washed with either solution. The use of a well soaked cloth, sponge, brush (with very soft bristles), or a low pressure spray washer is advised.

We do not recommend the use of scouring powders or industrial solvents, since these agents may damage the film. Solvent containing cleaners such as Fantastic®, however, are very effective and can be used without concern. If mildew or other fungal growth is a problem and cannot be removed as outlined above, household bleach, mixed at a concentration of one cup of bleach to five gallons of water, along with one cup of a mild soap (e.g., Ivory) to aid wetting, is recommended.

Once the metal roofing panels is washed, thorough rinsing with clear water is necessary to eliminate the possibility of residue. Failure to remove all residues from these cleaning steps may damage the film.

**SHERWIN  
WILLIAMS®**  
**Coil Coatings**



**RETURN POLICY:** Our policy lasts 30 days. If 30 days have gone by since your purchase, unfortunately we can't offer you a refund or exchange. To be eligible for a return, your item must be unused and in the same condition that you received it. It must also be in the original packaging. To complete your return, we require a receipt or proof of purchase.

Refunds (if applicable)

Once your return is received and inspected, we will send you an email to notify you that we have received your returned item. We will also notify you of the approval or rejection of your refund.

If you are approved, then your refund will be processed, and a credit will automatically be applied to your credit card or original method of payment, within a certain amount of days.

**PAYMENT:** BuyMetalRoofingDirect.com accepts Visa, MasterCard, Discover Card and American Express. Returned checks will be assessed a \$35 dollar return check fee.

**DELIVERY POLICY:** Delivery charges apply to all orders where delivery is requested. Please call for details.

**SALES TAX:** All orders picked up at Buy Metal Roofing Direct, and all orders delivered within the State of Florida, are subject to State Sales Tax. Tax Exemptions should be verified prior to delivery or customer pick up. Orders delivered out of state are tax exempt.

**WARRANTED PRODUCTS:** Request written warranty for details.

**INDEMNITY:** All prices and designs are subject to change without notice.

**DISCLAIMER:** While we have made every attempt at accuracy in this manual, we are not responsible for typo, graphic, printing or technical errors.

The success of BuyMetalRoofingDirect.com has been, and will continue to be, because of our valued customers. We strive to be a company where contractors as well as homeowners are welcome. We will assist you in calculating the materials needed to complete your project and at a price you can afford. We understand that our customer's time is important and we make every effort to get you in and out as quickly and efficiently as possible. Quality, price, service and availability are the mainstays of our business and we don't plan on changing it.





BUY METAL ROOFING  
**DIRECT**

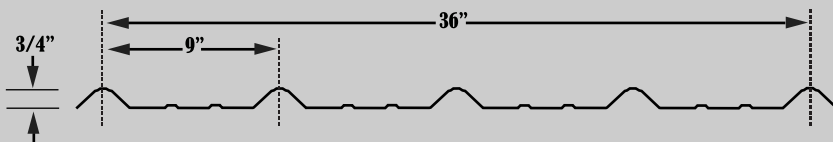
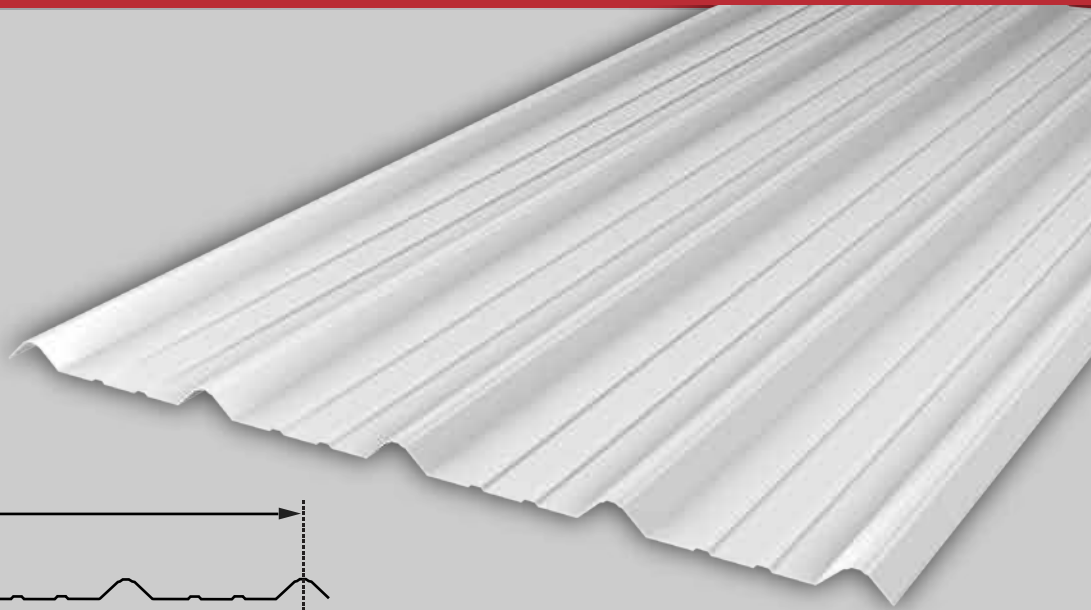

AVAILABLE IN



GALVALUME®

**TUFF RIB  
INSTALLATION MANUAL**